

Data sheet – area temperature control copper parallel flow



Three components are decisive for the feeling of comfort: air and surface temperature as well as the air humidity in a room. If they are in due proportion to each other, you feel comfortable. A good room climate and pleasant room acoustics help people to concentrate better and work more relaxed.

However, it is often difficult to combine all three requirements in a cost-effective and sophisticated manner. We took on this complex task and developed a slat system that cools and heats the room and significantly reduces the

reverberation time in the room. The HAUFE area heating system clearly stands out from many commercially available air-handling ceilings due to its extremely positive cost balance. Thanks to flow temperatures of 19 to 20 °C for cooling and 26 to 28 °C for heating, as well as a large flow volume, the running operating costs are significantly lower than conventional heating/cooling systems.

Construction of the system

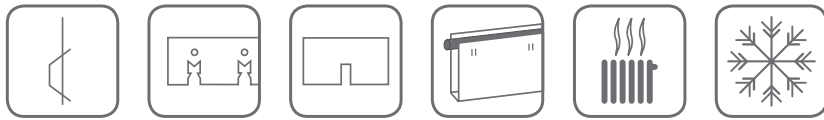

Hanger with mounting rails (construction without suspension wire)

suspension wire is not included has to be provided by the customer

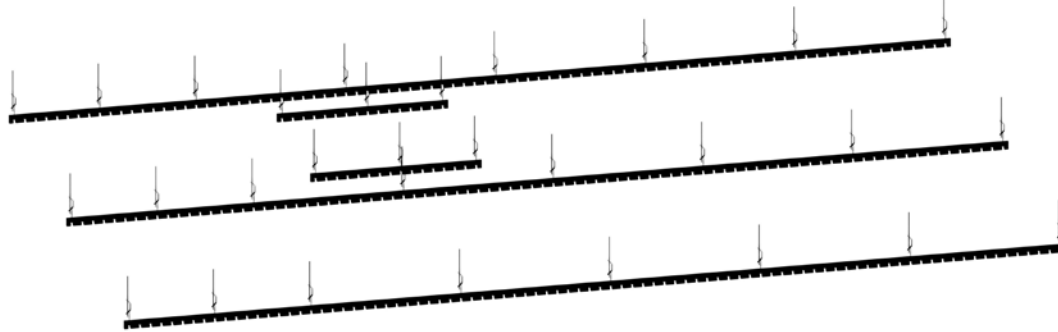

Installation of the heating elements

heating circuit distributor, inflow and return flow must be provided by the customer

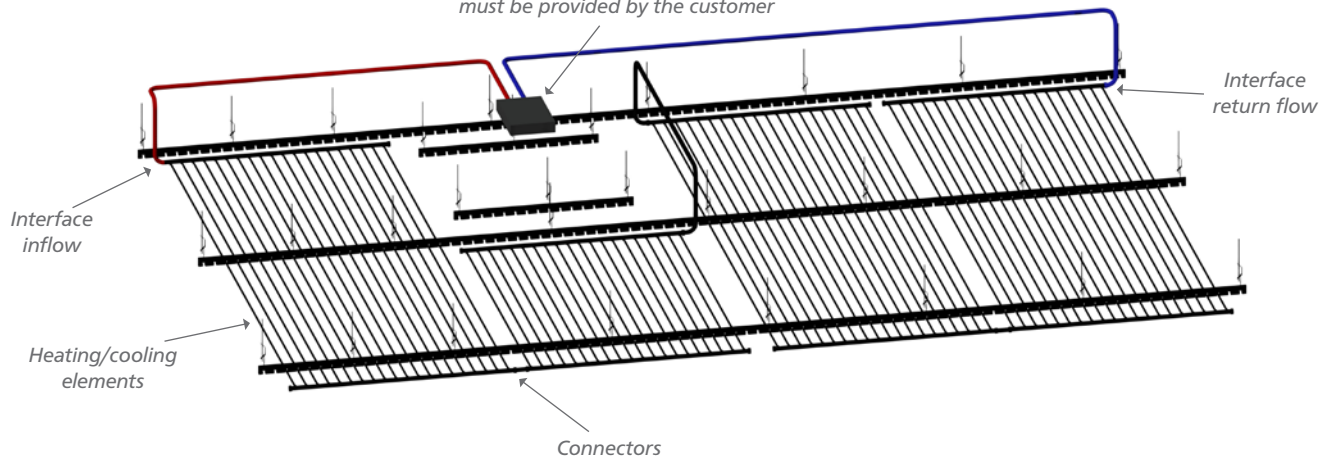

Installation of the slats and inspection element

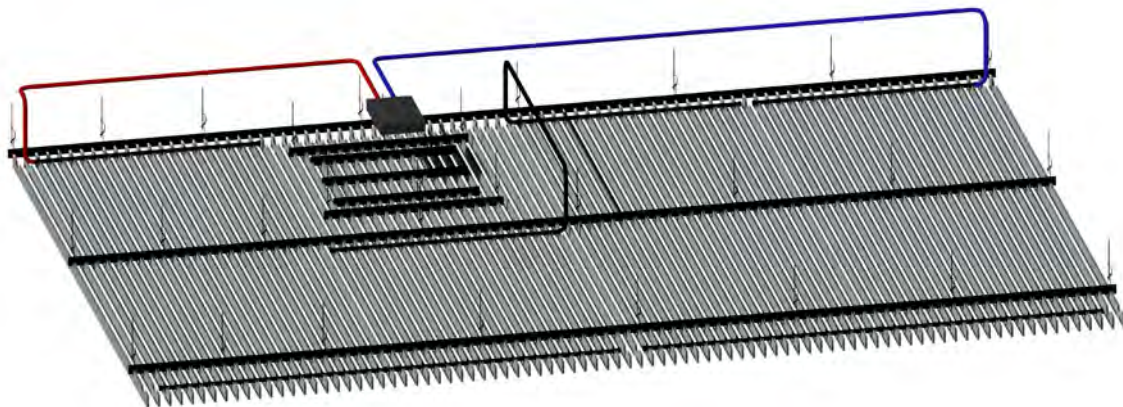

System structure

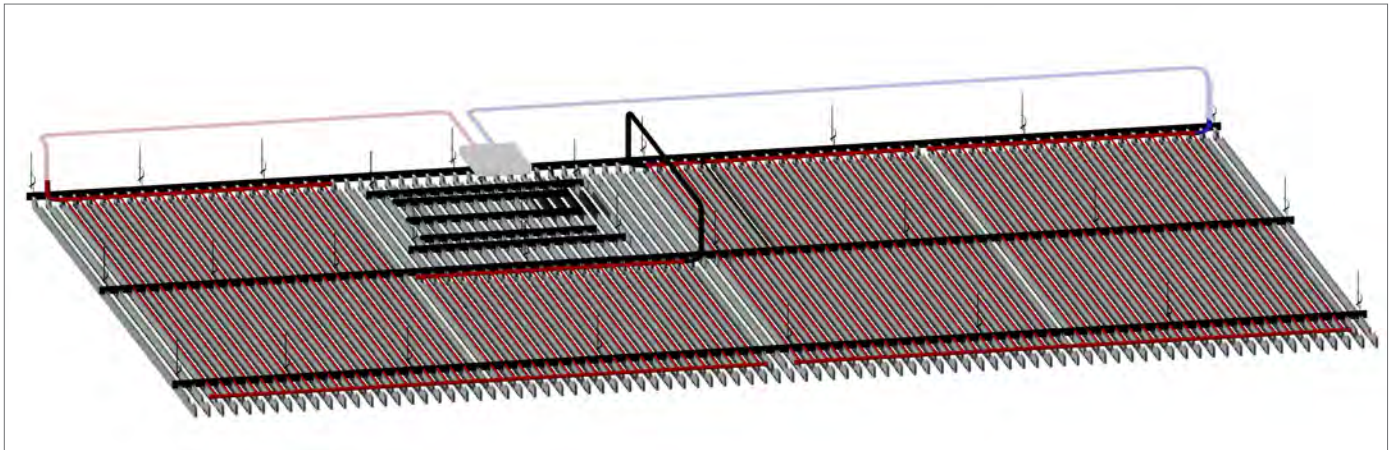
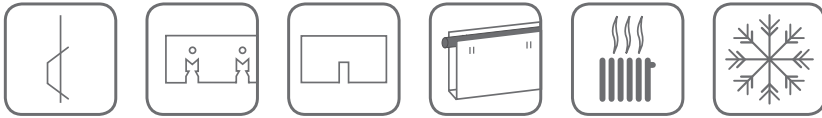

HAUFE area temperature control consists of the following elements:

- adjustable hanger lower part
- mounting rails
- copper heating elements
- slats
- slat connector Lamellenverbinder
- optional: Revisionsklappen

The flow and return as well as the heating circuit manifold must be provided on site by the respective heating engineer. The components of the HAUFE panel heating system are related up to the interface on the flow and return.

The connectors or connecting pieces between the individual heating elements are not included with the heating elements and are shown separately as an item in the quotation.

Installation of the system

The slat system is suspended from the bare ceiling using a suspension eyelet wire (to be provided by the customer), with the quick-release hanger connecting the wire to the mounting rail.

The distance between the hangers should be approx. 700 mm. The hanger can be suspended above each punched hole in the trunking. The mounting rail spacing does not follow a predetermined grid, but can be planned at irregular intervals according to the TGA installations in the bare ceiling area and other constraints.

The heating/cooling elements are fixed to the support rails between the support rails using cable ties or Velcro tape. The elements are connected to each other and connected to the flow and return pipe of the heating circuit, which

has already been laid in advance by the heating engineer. A heating circuit consists of 4 to 6 elements, several heating circuits can be connected to the heating circuit manifold (to be provided by the customer).

To stabilise the system, 3 to 4 slats can now also be clipped into the support rails from below. The joint of the slats is pulled together and aligned with a slat connector. The slat connector locks the slat/support rail connection.

HAUFE area temperature control

Technical data:

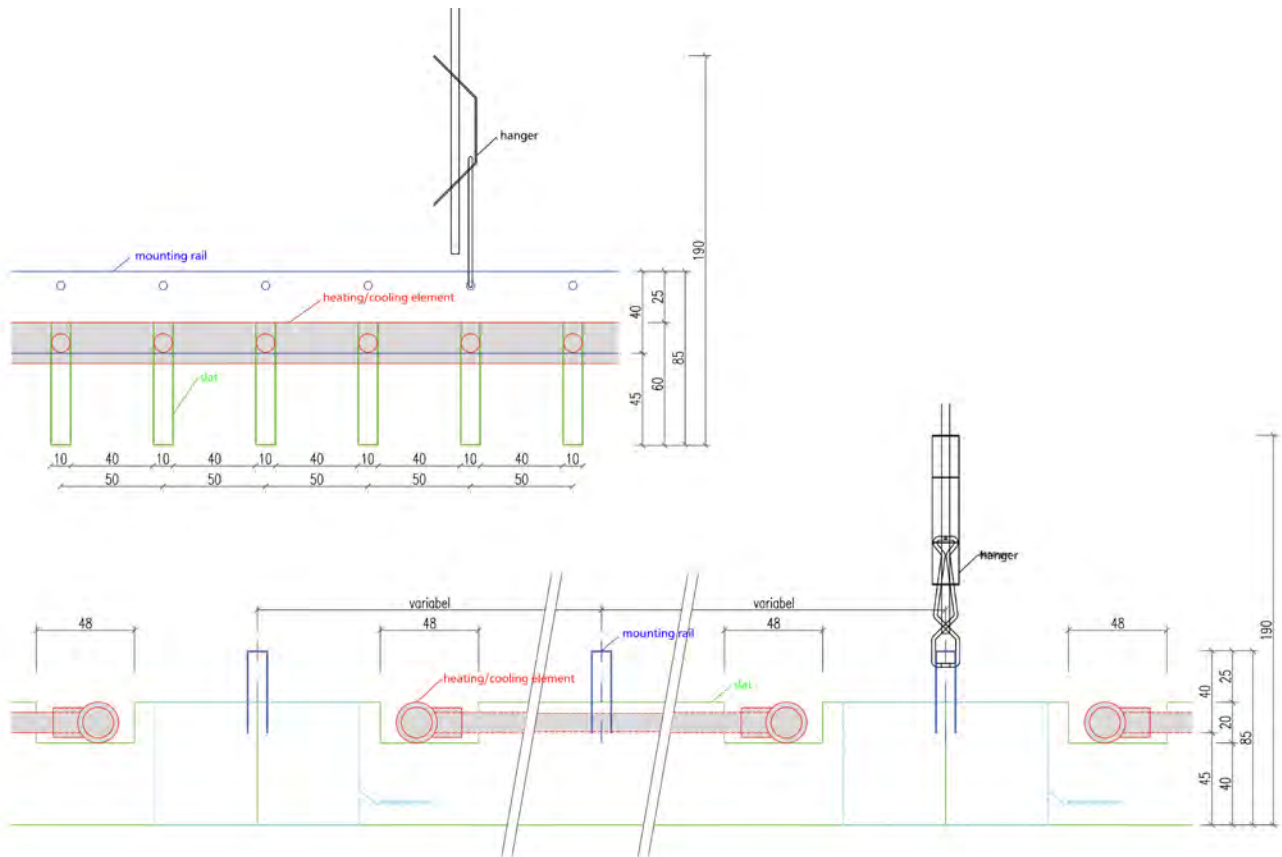

HAUFE area temperature control

Material:	pre-painted aluminum, stove enamelled
Material thickness:	0.4 mm
Slat height:	60 mm
Slat width:	10 mm
Max. slat length:	2,850 mm
Module:	50 or 100 mm
Color:	Standard colors RAL 9003/9016, special colors according to RAL and NCS feasible

Heating/cooling element

Material:	copper
Size:	according to plan width: 1,000 mm, length 2,632 mm custom solutions on request
Color:	copper
Oxygen Diffusion:	oxygen diffusion-tight
Fire protection class:	A

Further technical information

Installation height:	85 mm (slat + mounting rail)
Weight/m ² (mod. 50):	filled: 8.0 kg/m ² incl. supporting construction

HAUFE area temperature control

Facts

- Diffusion-tight version
- Cooling capacity approx. 130 W/m² (at Δt coolant temperature to room air temperature 10 K)
- Heat output approx. 120 W/m² (at Δt 15 K)
- Energy saving with the same temperature perception
- Uniform temperature distribution
- Short heating and cooling times
- Installation height 85 mm
- Inspection feasible
- Simple installation
- Integrated luminaire program

You can request test certificates directly from us.

Pressure level

Pressure rating PN10, approved connectors up to 10 bar. The pressure loss of the surface temperature control elements integrated in the HAUFE ceiling settles by the number of elements per heating/cooling circuit and the supply and return line to the heating/cooling circuit distributor together. On average there are 3 to 5 surface temperature control elements connected in series (planned) and the total length of the flow and return lines should be 20 m to 25 m not exceed. At the maximum element set and line length is the pressure drop per heating/cooling circuit until to 12 sqm approx. 200 to 250 mbar.

Planning information

- Hanger spacing in the direction of mounting rails 700 mm
- Mounting rail spacing is planned flexibly. The average spacing is 800 mm, the maximum spacing can be 1,500 mm (only sporadically).
- HAUFE creates a workflow and installation planning after the receipt of the order, submission of the required planning documents and the site measuring.
- Slat lengths, installations and spacing between the mounting rails will then be perfectly adapted to the spatial conditions.
- A direct continuing of the slats without heating/cooling elements is easily feasible. However, this area must be indicated separately in the service specifications and visibly defined in the plan.

Tempering with parallel flow

- Flow temperatures when heating: 25° C to 28° C (spread 2 K)
- Flow temperatures when cooling: 19° C to 20° C (spread 2 K)
- Large flow volume
- Pleasant room temperature of approx. 23° C
- Short reaction time for a pleasant temperature
- Low pressure loss

Pressure loss example at element 275-5

Size:	length 275 cm, pipe spacing 5 cm, width 1 m
Flow rate:	e.g. 5 l/min
Pressure loss per element:	6 mbar

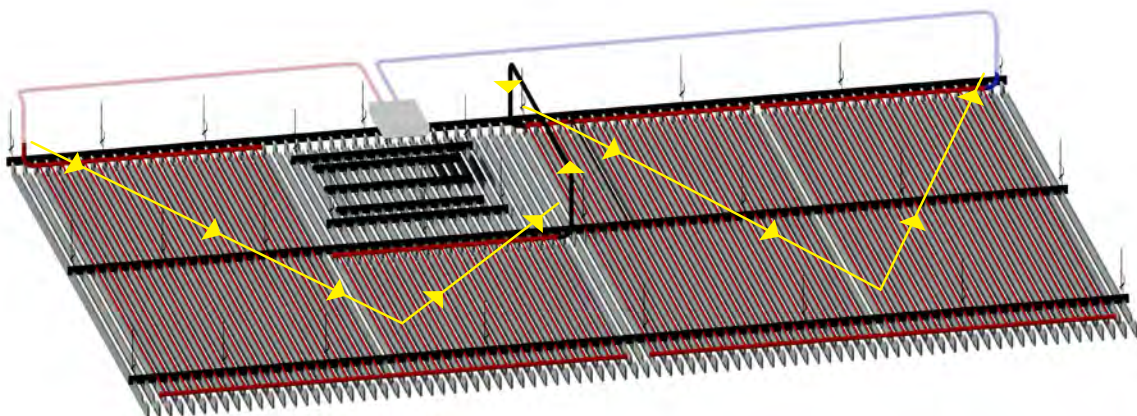

Comparison of HAUFE surface temperature control systems

Surface temperature control made of PP-R

Facts:

- Heating circuit manifold and supply line are included, interface is located in the heating circuit manifold
- Lighter weight
- Larger scope of delivery possible
- Flexible element sizes, price-neutral

Heating/cooling element	
Material:	polypropylene
Size:	according to plan width: min. 500 mm, max. 1,000 mm length: min. 750 mm, max. 2,750 mm custom solutions on request
Color:	black
Oxygen Diffusion:	Since the system is not oxygen diffusion-tight, a constructive system separation has to be achieved.
Fire protection class:	B

Further technical information	
Installation height:	85 mm (slat + mounting rail)
Weight/m ² (mod. 50):	filled: 4.5 kg/m ² incl. supporting construction

Interface	
Connection	through Polyfusion welding technology
Interface:	The interface for the heating connection is located in the heating circuit distributor. System including connecting parts to the heating circuit distributor and the required heating circuit distributors. The required quantity of connecting parts/supply lines as well as the heating circuit distributors are included in the price per square meter of the surface temperature control.

Surface temperature control made of copper

Facts:

- Supply lines to the heating circuit are exclusive, interface is at the heating circuit element input
- Fire protection class A
- Diffusion-tight
- High system performance

Heating/cooling element	
Material:	copper
Size:	according to plan width: 1,000 mm, length 2,632 mm custom solutions on request
Color:	copper
Oxygen Diffusion:	oxygen diffusion-tight
Fire protection class:	A

Further technical information	
Installation height:	85 mm (slat + mounting rail)
Weight/m ² (mod. 50):	filled: 8.0 kg/m ² incl. supporting construction

Interface	
Connection:	The plug connectors or connecting pieces between the individual heating elements are not included in the heating elements and are shown separately as an item in the offer.
Interface:	The interface for the heating connection is located at the element heating circuit input and heating element output

Lip and slat connectors

Lip

As a rule, the slat ends with a 20 mm shadow gap before the wall. The slat can project up to 300 mm. We provide lip profiles on request.

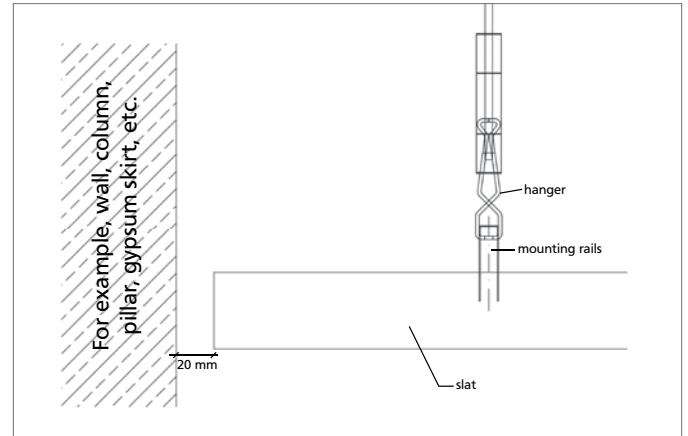

The mounting rail should also be mounted with some spacing to the wall (10-20 mm). The entire system must hang self-supporting within the room. Fixing it to adjacent components is strongly discouraged. The mounting rail must project the last slat at least 5-10 mm to fully include it.

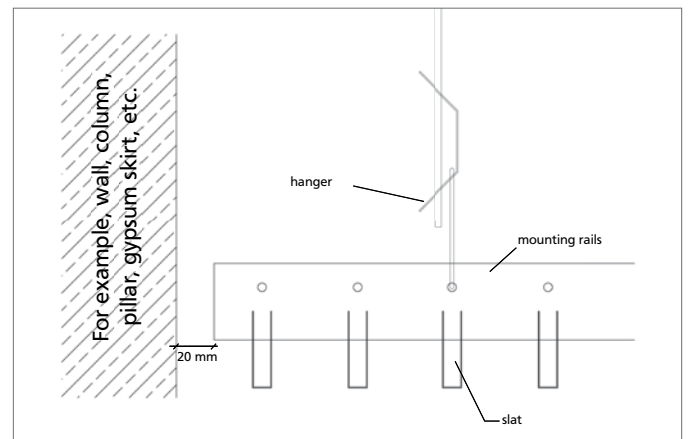

Slat connectors

To connect the slats, the slat connector is slid into the mounting rail with the closed side upwards into the press cut. Then the slats are snapped into place in the mounting rail from both sides. Finally, the connector is slid into the slats.

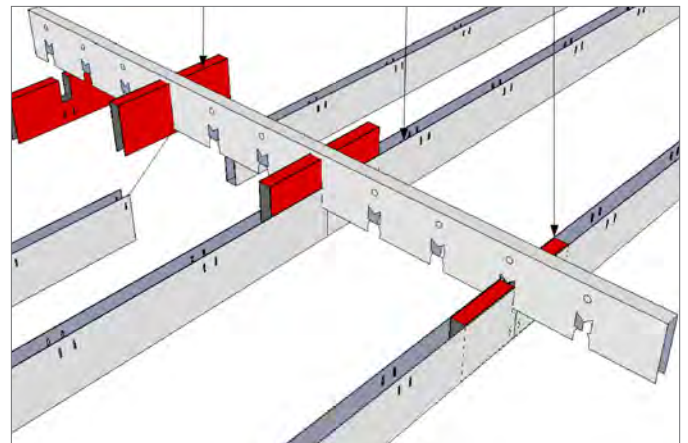

ZUMTOBEL linear light INLINE



Together with Zumtobel, we have developed a luminaire that fits perfectly into our slat ceiling.

Thanks to their low installation height and their excellent glare control, ZUMTOBEL light strips can be easily integrated into the HAUFE slat system across the board. The solution combines aesthetics, light, air conditioning and soundproofing.

There are three variants for different applications without breaking the architectural style:

- recessed lights
- surface-mount modules
- pendant modules

LINK



Accent lights are also available, which can be used either as selective accent lighting or as an accent/linear combination.

ZUMTOBEL linear light INLINE

INLINE recessed light

Light strips and recessed lights developed by ZUMTOBEL for the HAUFE slat systems can be integrated into the system across the board. The position of the lights can be determined independently of the position of the mounting rails, since the light strips rest on the slats with tool-free snap holders. The low installation height of 25 mm avoids interrupting the mounting rail.

The system light is routed underneath the mounting rail. This greatly simplifies the interface between the drywaller who installs the slat system and the electrician who usually supplies and installs the lighting. The power supply sits directly on the lamp. The power pack and lamp have a total installation height of 70 mm.

- System luminaires for tool-free integration into HAUFE system ceilings for different slat heights (40 mm and 60 mm)
- Symmetrical wide-beam, homogeneous light distribution with a beam angle of $> 60^\circ$.
- Defined light emission for glare-free light distribution in accordance with EN 12464-2011 with UGR < 19
- Luminaire luminous flux (DALI dimmable): 1500 lm (16 W), 2000 lm (21 W), 2500 lm (26 W), 3000 lm (32 W)
- Colour rendering index: $R_a > 90$
- Colour temperature: 3000 K (LED930: warm white) or 4000 K (LED940: neutral white), 3500 K on request
- Enclosure colour in black or white (other colours on request)
- Integration of emergency lighting central battery systems according to EN 60598-2-22



Einbauleuchte

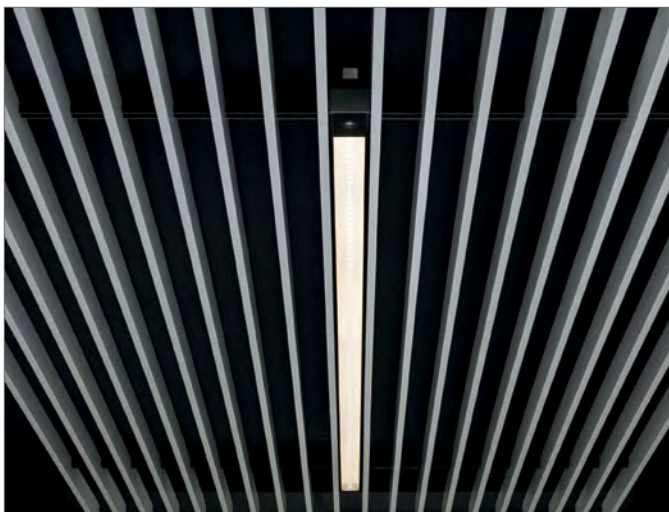

recessed light white with sensor



recessed light black with sensor

Advice and sales are provided exclusively by our system partner ZUMTOBEL:

Germany: Albert.Pummer@zumtobelgroup.com
Austria: Roman.Brandstaetter@zumtobelgroup.com

ZUMTOBEL linear light INLINE

INLINE surface-mount module

- LED surface-mounted in compact, slimline design and the same design as the Supersystem inline recessed module
- LED driver in the ceiling rose provides a central location for the feed (outlet)
- Intuitive height adjustment via patented suspension mechanism, maximum suspension length 3m
- Connected load: 21 W, 26W or 32 W
- Module lengths: 750 mm, 1000 mm, 1200 mm and 1500 mm
- Symmetric, wide beam, uniform light distribution with 60° beam angle
- Defined light emission for glare-free light distribution in accordance with EN 12464-2011 with UGR < 19
- Light control via a high-quality aluminium-sputtered primary reflector unit made of polycarbonate (PC) in combination with a multilayer MPO+ micro-pyramidal optic
- Further variants available in OPAL and UGR < 22
- Colour rendering index: Ra > 90
- For use with 220 V DC central battery in compliance with EN 60598-2-22

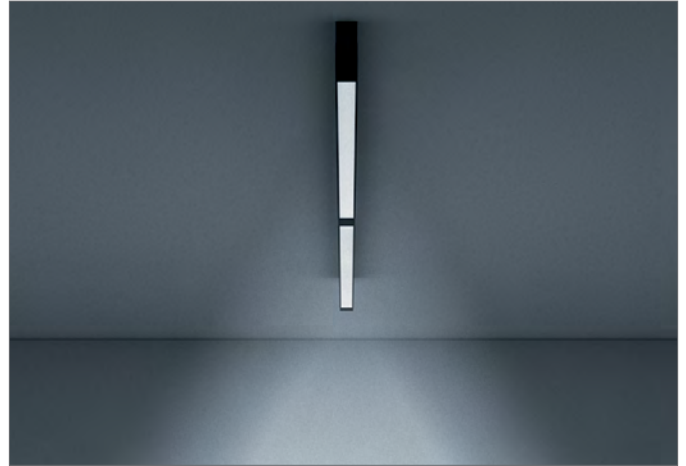

INLINE light as surface-mount module

INLINE Pendelleuchte

- Intuitive height adjustment via patent hanger, maximum pendulum length 3m
- LED pendant module in compact, slimline design and the same design as the Supersystem inline recessed module
- LED driver in the ceiling rose provides a central location for the feed (outlet)
- Intuitive height adjustment via patented suspension mechanism, maximum suspension length 3m
- Connected load: 21 W, 26W or 32 W
- Module lengths: 750 mm, 1000 mm, 1200 mm and 1500 mm
- Symmetric, wide beam, uniform light distribution with 60° beam angle
- Defined light emission for glare-free light distribution in accordance with EN 12464-2011 with UGR < 19
- Light control via a high-quality aluminium-sputtered primary reflector unit made of polycarbonate (PC) in combination with a multilayer MPO+ micro-pyramidal optic
- Further variants available in OPAL and UGR < 22
- Colour rendering index: Ra > 90



INLINE light as pendant module

ZUMTOBEL linear light INLINE

INLINE accent lights

- System luminaires for tool-free integration into HAUFE system ceilings for different slat heights (40 mm and 60 mm)
- 6 miniaturised single light heads in linear arrangement
- Mounting: with fixing springs in the slatted ceiling
- Reflector in the colours white, copper and aluminium
- Colour temperature: 3000 K (LED930: warm white) or 4000 K (LED940: neutral white)
- High colour rendering CRI>90



Point accent lighting



accent/linear combination



triple combination of accent lights

HAUFE Air diffuser for open ceiling systems

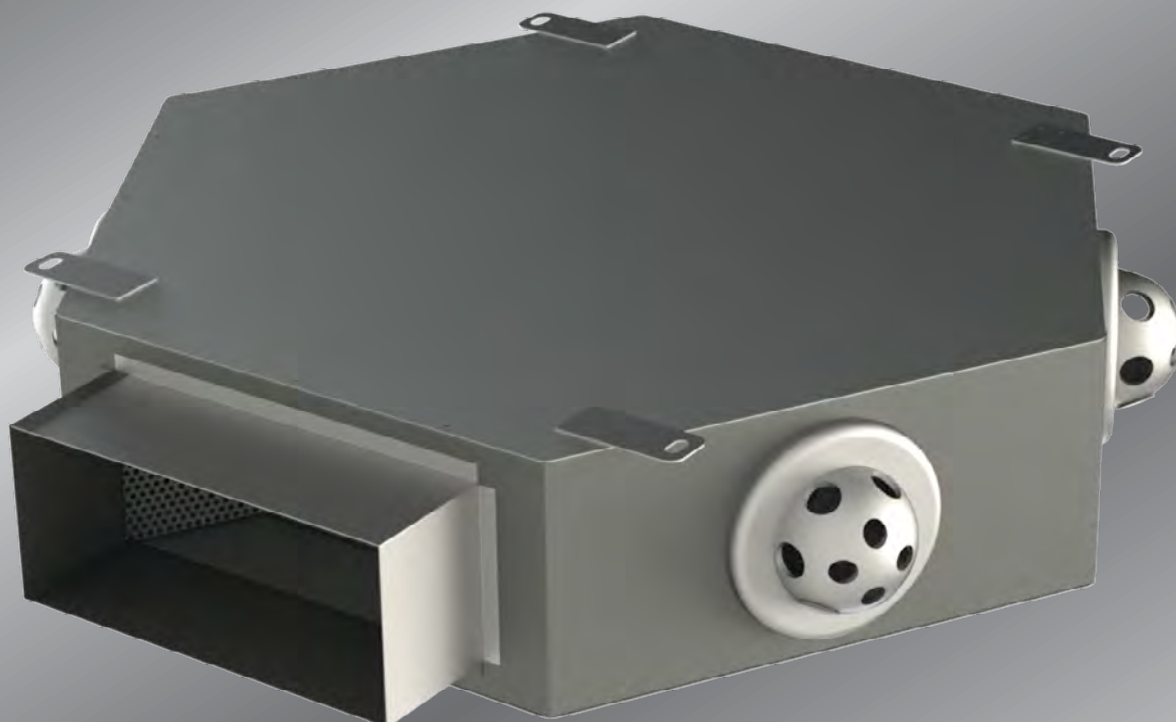

We have had an innovative air outlet developed especially for the HAUFE lamella ceiling. It can be installed invisibly and in a space-saving manner on the ceiling.

With the low construction height of 180 mm and a recommended distance of 40 mm to the upper edge of the lamella ceiling, total construction heights (incl. lamella ceiling) of 285 to 305 mm can be realised. Since there is no physical connection to the slat ceiling, both the slat ceiling and the ventilation system can be installed without interface problems.

Although the air outlet can move an air volume of 300 m³/h at 30 dB (A), there are no noticeable draughts when the room air is mixed. The exhaust air unit, which is almost identical in construction, transports up to 600 m³/h of exhaust air out of the room.

The cooling capacity of the HAUFE surface temperature control can be increased in conjunction with this air diffuser. Compared to a slot diffuser, you can count on uncomplicated installation and at the same time have a very good price-performance ratio.

HAUFE Air diffuser for open ceiling systems

Fields of application

The air diffuser for open ceiling systems LOD is suitable for use in supply and return air installations, for direct connection to the duct system and it is suitable for VAV systems with variable volume flows. The air diffuser is placed directly above an open ceiling system on the raw ceiling.

Function

Both in cooling and heating mode, the air diffuser for open ceiling systems LOD generates a very high induction after blowing out the supply air, thus effectively reducing air velocity and temperature above the open ceiling system. The supply air flows out evenly over a large area and descends into the occupied area at a very low velocity. The field of application of the LOD in cooling mode is at Δt of ≤ -8 K. The supply and return air diffusers are supplied with air or connected directly to the duct system.

Volumetric flow range

Depending on the selected size and model, the volume flow range of the LOD is 35 dB(A) at approx. 670 m³/h in the supply air and in the return air, use in VAV systems of 100 - 40% possible.

Technical info:

- Can be mounted above the HAUFE slatted ceiling
- No trade interfaces ventilation/ceiling
- Mounting to the raw ceiling (sound decoupled)
- „invisible“ black lacquered
- No disturbance of the ceiling optics
- Supply air in cooling mode $\Delta T = 8$ K
- 300m³/h at $L_{wa} = 30$ dB(A)
- Overall height 180mm
- Distance to top edge of ceiling construction ideally 50mm
- Distance between air outlets ideally > 3m

Heating

- 350m³/h per diffuser, $LW = 5$ 1/h
- Sound power $L_{wa} = 35$ dB(A)
- Discharge height 4m
- Flow temperature ceiling 30°C
- Supply air temperature 22°C, $\Delta T = 6$ K
- Room mixing within a very short time
- Vertical temperature curve corresponds to DIN EN ISO 7730
- category A

Cooling

- 235m³/h per diffuser
- $L_{wa} = 27$ dB(A)
- $\Delta T = 6$ K Cooling

LINK



rectangular connection (standard)



round connection